

# Operating Manual

**Process photometer**

**AQUACON Fe10**  
**(PC- Cabinet)**

May 2011

Fillerkampsweg 1 – 5 • 31832 Springe OT Eldagsen • Tel.: 0049(0)5044/887-0 (Fax: -99)

E-Mail: [info@iotronic.de](mailto:info@iotronic.de)





Internet: <http://www.iotronic.de>





<b>1</b>	<b>GENERAL GUIDELINES FOR SAFETY</b>	<b>3</b>
<b>2</b>	<b>PRINCIPLE OF OPERATION</b>	<b>4</b>
<b>3</b>	<b>DESCRIPTION OF THE PROCESS PHOTOMETER</b>	<b>4</b>
3.1	Analytical Part	7
3.2	Measurement and Control	7
3.3	Operation and Measurement Security	7
3.4	Automatic Operation	8
3.5	Manual Operation	9
3.6	Display/Set Parameters	10
3.6.1	Limit Value	11
3.6.2	Alarm value	11
3.6.3	Analog Output setting (mode, start value and end value)	11
3.6.4	Sampling Interval	12
3.6.5	Titer/Calibration Factor	12
3.6.6	Rinsing Time	12
3.6.7	Reagent Volume	12
<b>4</b>	<b>SWITCHING FUNCTIONS OF THE AQUACON FE10</b>	<b>13</b>
4.1	External Switching	13
4.2	Display in the standby mode	13
4.3	Analysis state relay	13
4.4	Limit Value Relay	14
4.5	Alarm Limit Relay	14
4.6	Current Output	14
<b>5</b>	<b>START-UP AND MAINTENANCE INSTRUCTIONS</b>	<b>15</b>

5.1	Connection of sample water	15
5.2	Connection of reagent, bleeding of pumps and tubes	15
5.3	Replenishment of Reagent	15
5.4	Changing of Tube box	15
5.5	Recalibration of the Process analyzer	16
5.6	Maintenance interval	16
5.7	Shut down procedure	16
<b>6</b>	<b>ALARM MESSAGES</b>	<b>17</b>
<b>7</b>	<b>TECHNICAL DATA</b>	<b>17</b>
<b>8</b>	<b>SPECIFICATIONS</b>	<b>18</b>
<b>9</b>	<b>CONNECTION DIAGRAM</b>	<b>18</b>
9.1	Set 0/4 - 20 mA-Output	18
9.2	Connections	19
9.3	Installation	20
<b>10</b>	<b>APPENDIX</b>	<b>21</b>
10.1	Analysis cycle Fe10	21
10.2	Spare part and consumable item list	22
<b>11</b>	<b>TROUBLESHOOTING GUIDE</b>	<b>23</b>

## 1 General Guidelines for Safety

	<b>WARNING</b>	(Non-observance or misapplication of the contents of the „Warning“ section could lead to serious accident, including death or injury)
<b>Turn off the power supply.</b> Working without disconnecting the power supply may cause an electrical shock. Before engaging upon any working procedures make sure to disconnect the power supply.		 Electrical Shock
<b>No remodelling !</b> Never remodel an analyzer. Otherwise, a serious accident may result. IOTRONIC will not be responsible for any accident or damage of any kind which is caused by the user remodelling the analyzer.		 No Remodeling
<b>Operating site must be free of water and humidity</b> The analytical instrument is not designed to be water-proof or dust-proof. The use of the analyzer in places where water splashes or humidity is high may result in an electrical shock or short-circuit.		 Prohibited

	<b>CAUTION !</b>	(Non-observance or misapplication of the contents of the „Caution“ section could lead to serious physical injury to the user or serious damage to the product.)
<b>Specified power only</b> Do not operate the analyzer on voltage which is not specified on the label on the right side of the transmitter housing. Failure to do so can result in damage or fire. Only the specified power level is to be applied.		 Caution
<b>Do not damage or change power cable !</b> Do not scratch, damage, process, or pull the power cable forcibly. Non-observance could cause a fire or an electrical shock.		 Caution

### Notes on operation

- Dropping the device or subjecting it to strong impacts may result in faulty performance. Handle the analyzer with care.
- Select an installation site convenient for future maintenance and inspection, and fix the device carefully so that it is free of vibrations.

## **2 Principle of Operation**

The process photometer for the measurement of iron in water AQUACON Fe10 performs a discontinuous photometric determination of iron (solved  $\text{Fe}^{2+}$ ,  $\text{Fe}^{3+}$ ) on the sample being measured. The entire operation, which includes filling and rinsing of the measuring cuvette, is controlled by a microprocessor.

The proprietary reagent formulations developed by the manufacturer are added to the measuring chamber by means of a tube pump and mixed with the sample in the measuring chamber. The color formed as a result of the reaction is detected by the monochromatic photometric detection system built into the measuring chamber. The measured absorbance is a function of the iron concentration. The result will be displayed on the touchscreen as ppb  $\text{Fe}^{2+}$ ,  $\text{Fe}^{3+}$ .

## **3 Description of the Process Photometer**

The process photometer is delivered completely mounted in a polycarbonate wall cabinet, ready for installation. This includes all the components for sample and drain connection, measurement chamber, reagent pumps, display and connections for remote display and control. All functions of the process photometer can be operated via touchscreen.

View of the process photometer AQUACON Fe10

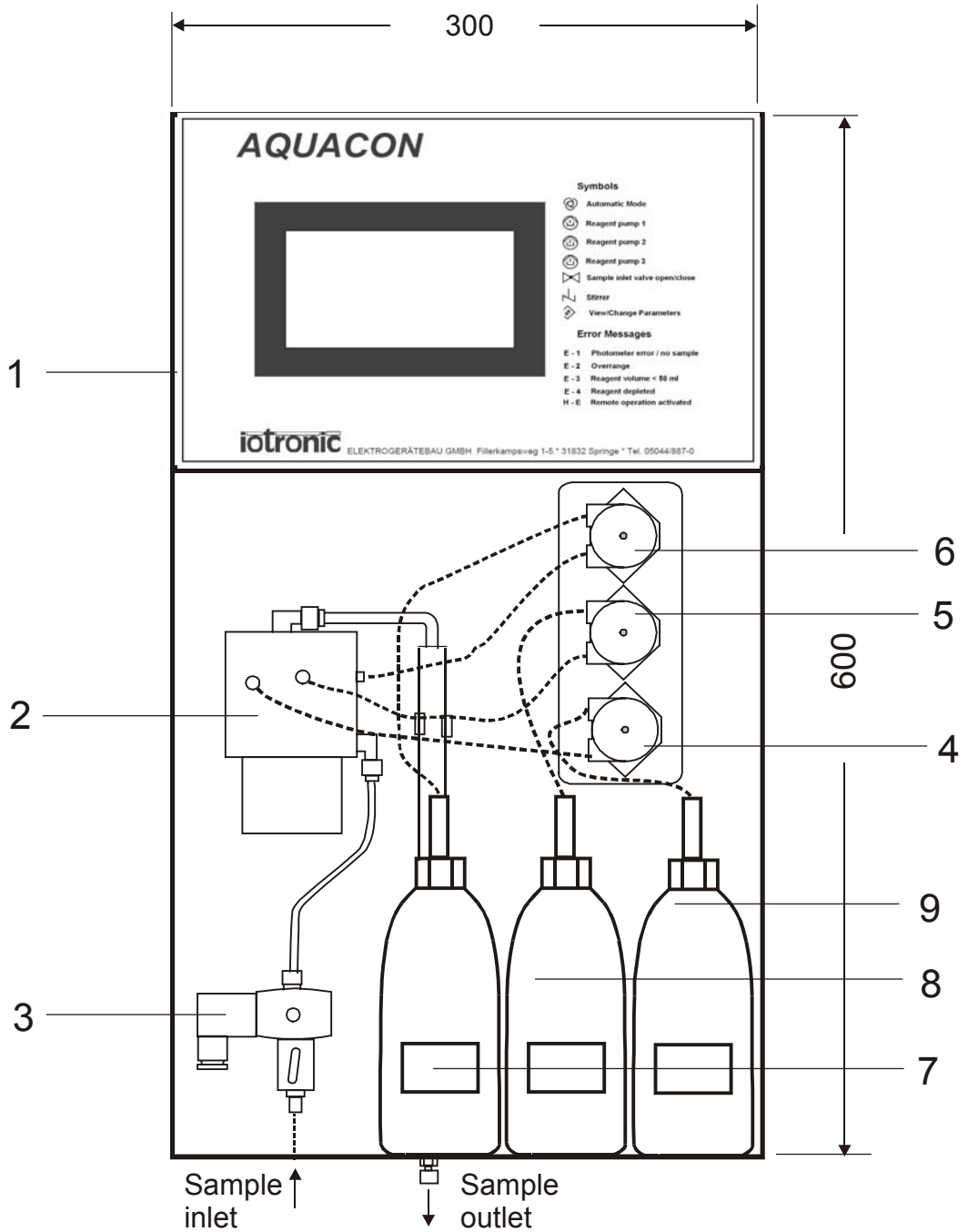







- 1 Transmitter
- 2 Measuring chamber
- 3 Sample inlet valve
- 4,5,6 Reagent tube pump
- 7 Reagent 1 vessel (250 ml)
- 8 Reagent 2 vessel (250 ml)
- 9 Reagent 3 vessel (250 ml)

**AQUACON FE10 Display and Keyboard**

# AQUACON



**Symbols**

-  Automatic Mode
-  Reagent pump 1
-  Reagent pump 2
-  Reagent pump 3
-  Sample inlet valve open/close
-  Stirrer
-  View/Change Parameters







**Error Messages**

- E - 1 Photometer error / no sample
- E - 2 Overrange
- E - 3 Reagent volume < 50 ml
- E - 4 Reagent depleted
- H - E Remote operation activated



ELEKTROGERÄTEBAU GMBH Fillerkampsweg 1-5 \* 31832 Springe \* Tel. 05044/887-0

**Explanation of Symbols**

Symbol	Function
	Select Automatic Mode, start an analysis
	Reagent pump 1 on/off
	Reagent pump 2 on/off
	Reagent pump 3 on/off
	Sample inlet valve open/close
	Stirrer on/off
	View / Change parameters



### **3.1 Analytical Part**

The transmitter of the process photometer AQUACON Fe10 is contained in a compact housing and includes the microprocessor which recognizes the absorbance (extinction), displays the final calculated result on a touch screen and controls the operation of the process photometer with respect to sampling, rinsing of the measurement chamber, dosing of the reagent and surveillance of the photodetection system.

### **3.2 Measurement and Control**

The user may set a freely-programmable maximum limit of the measured value, which, when exceeded, will activate a relay contact which is found on the connection terminal rail (see chapter 3.6.1). In addition, an analog 0/4-20 mA current output delivers a signal proportional to the measured values (see chapter 9.1). The start and end of output range are programmable (see chapter 3.6.3).

All user-defined settings are maintained during power failure to the instrument.

### **3.3 Operation and Measurement Security**

When the end-user defined maximum alarm value is exceeded or when an error occurs (ERROR E-1 to ERROR E-4) the alarm relay will activate.

The actual reagent volume of reagent 1 is calculated by the microprocessor and is corrected for usage after each analysis. Once the calculated remaining reagent volume falls below the factory-predetermined value of 50 ml, an alarm message (ERROR E-3) is displayed on the touchscreen and the alarm relay (found on the transmitter terminal connector) is activated. The remaining 50 ml reagent is sufficient for approximately 60 analyses. Should this alarm be ignored and the reagent is depleted, a second alarm message (ERROR E-4) is displayed on the touchscreen, subsequent relay activation is initiated by the process photometer AQUACON Fe10 and the analyzer stops.

The optical transparency of the measurement cuvette is measured at the start of each analysis. An automatic zero adjustment takes place before each measurement to compensate colored or turbid samples or discoloration/contamination of the cuvette windows. Once the factory-predetermined limit to the zero adjustment is exceeded, another alarm message (ERROR E-1) is displayed on the touchscreen, the alarm relay is activated and the analysis cycle is interrupted.

In the event of sample failure, the photometer will detect this and display the alarm message ERROR E-1 on the touchscreen, activate the alarm relay and interrupt the measurement.

When the sample interval defined by the end-user has elapsed, the process photometer will automatically resume measurement as normal and repeat the procedure until sample flow is re-established.

The analysis cycle may be interrupted at any stage by touching the button “Hand” or the button “Param” on the touchscreen.

The process photometer remains in manual operation mode until the automatic mode is selected by pressing the appropriate symbol or touch button.

### **3.4 Automatic Operation**

The process photometer will automatically carry out an analysis once the “Start” button is pressed.

On the return of power, following a power failure, the process photometer will automatically enter the automatic mode and starts a measurement. This is displayed as state “MEASURING”.

On the touchscreen, the last actual measured value of analysis is displayed. If the result of analysis is lower than the low measuring limit of the analyzer, the display shows ”000 ppb.

Below the last measured value, the sets parameter for “Limit value” and for “Alarm value” are displayed. This values can be parametrized by the end-user (see chapter 3.6).

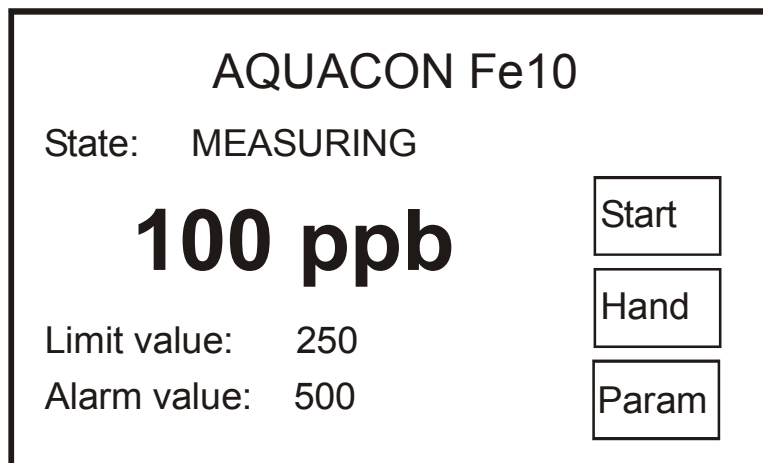

The automatic analysis cycle can be interrupted at any stage by touching the button “Hand” or the button “Param” on the touchscreen (see 3.5). After the finish of the analysis, the new measured value will be displayed on the touchscreen and the analyzer state is changed to “STANDBY”.

**When the upper measurement range is exceeded, the alarm message „ERROR E-2“ is displayed as state on the touchscreen and the alarm relay is activated.**

### 3.5 Manual Operation

Manual operation of the process photometer is useful for maintenance, commissioning of the analyzer and when correction of alarm conditions during normal operation occur.

Manual operation of the process photometer is effected by pressing the button “Hand” on the touchscreen. During the internal zero adjustment of the photometer short delays can occur. Automatic operation is interrupted and the screen displays the manual mode (state: MANUAL). Simultaneously, the actual absorbance (extinction) value is displayed in the upper display.

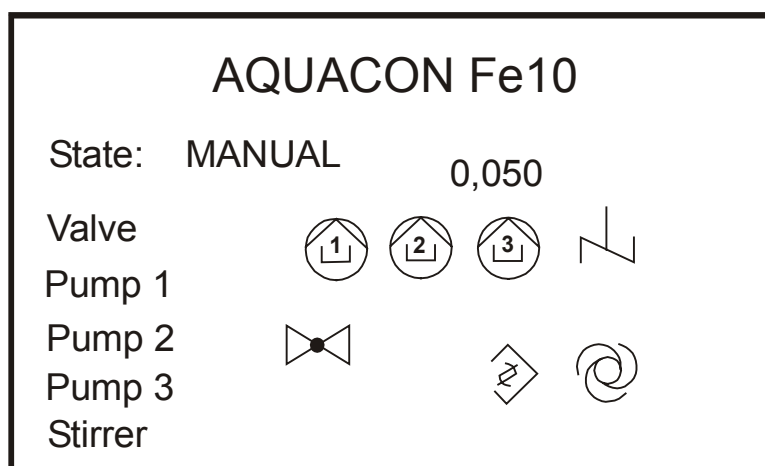

During manual operation, the pumps, the sample inlet valve and the stirrer can be activated/deactivated by touching the appropriate symbols. The active part will be displayed with inverse letters.

During manual operation, the mode can be switched to automatic mode and an analysis can be started by touching the symbol .

During manual operation, the mode can be switched to parameter mode by touching the symbol .

### **3.6 Display/Set Parameters**

The parameter mode can be activated from automatic mode by touching the button “Param” or from manual mode by touching the symbol 

AQUACON Fe10		
Limit value:	250	Start
Alarm value:	500	
Output mode:	4-20 mA	Hand
Output start:	000	>>
Output end:	500	

In parameter mode, a new screen will be displayed which shows the parameters Limit value, Alarm value, Output mode, Output start and Output end. By touching the button “ >> ”, a second screen will be displayed with the parameters Sampling interval, Calibration factor, Rinse time and Reagent volume.

AQUACON Fe10		
Sampling interval:	10	Start
Calib. factor:	1.00	
Rinse time:	15	Hand
Reagent volume:	250	<<

By touching the button “ << ”, the first parameter screen will be displayed again.

All parameters are set to a certain value (factory settings), but can also be parametrized by the end-user (see the following chapters 3.6.1 – 3.6.7).

To change the parameters, the corresponding values must be touched. Then, a parameter specific screen opens where the new parameter values can be typed by touching the figures (except parameter “Output mode”).

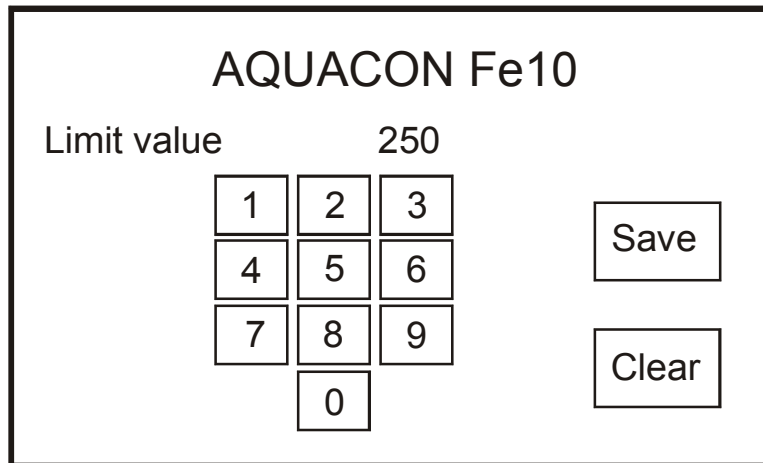

To leave the screen and confirm/save the new parameter value, the button “Save” must be touched. To leave the screen without saving, the button “Clear” must be touched.

### 3.6.1 Limit Value

The limit relay will activate when the end-user defined maximum limit value is exceeded. The factory-predetermined limit is set to 250 ppb. A value between 0 and 999 ppb may be chosen.

### 3.6.2 Alarm value

The alarm value is factory-predetermined to the upper measurement range 500 ppb. The alarm relay will activate when the end-user defined maximum alarm value is exceeded and an error message is shown on the touchscreen. A value between 0 and 999 ppb may be chosen.

### 3.6.3 Analog Output setting (mode, start value and end value)

An analog current signal (0/4 - 20 mA), proportional to the measured value, may be directed from the process photometer AQUACON Fe10 to remote recording/controlling devices. The mode, the start value and the end value of the analog output can be parametrized by the end-user.

The mode of the analog output can be switched from 0-20 mA to 4-20 mA by touching of the corresponding value on the touchscreen. No further confirmation is required. The start and end values can be set to values between 0 and 999 ppb. The set end value must be higher than the set start value.

### **3.6.4 Sampling Interval**

The sampling interval between two automatically initiated samples may be programmed. The factory-predetermined sample interval is set to 10 min. A values between 1 and 99 min. may be chosen.

### **3.6.5 Titer/Calibration Factor**

The process photometer AQUACON Fe10 may be re-calibrated by entering a titer/calibration factor (see chapter 5.5). A value between 0.00 and 9.99 may be chosen.

### **3.6.6 Rinsing Time**

The measuring chamber is rinsed for 15 seconds before an analysis takes place. The preset rinsing time may be altered by the end-user. A value between 15 and 99 seconds may be chosen.

Depending on the length of the sample inlet tube and the water flow rate, the rinsing time should be long enough to flush the sample lines and fill the measuring cuvette with fresh sample. A tube length of max. 5 m is recommended between sample valve and the analyzer.

### **3.6.7 Reagent Volume**

The remaining reagent volume of the 250 ml reagent container is calculated and stored in memory by the microprocessor. A value between 0 and 999 ml may be chosen.

The automatic operation mode starts again when the button “Start” is touched.

## 4 Switching Functions of the AQUACON Fe10

### CAUTION:

Before opening the cover below the process photometer display, the AQUACON Fe10 must be disconnected from the mains supply.

### 4.1 External Switching

The process photometer AQUACON Fe10 has a potential-free input contact which may be used to control the instrument from a remote position/device. When the input contact is closed the process photometer will automatically carry out an analysis, when the input contact is open the process photometer completes the actual analysis and stops.

The process analyzer is delivered with bridged external switching contact into female. For using external switching contact remove this bridge! During the interval between two analyses the process photometer may be activated by a short off/on impulse of the external contact.

### 4.2 Display in the standby mode

In the standby mode the display will show „H-E“ and the last measured value (the value that was determined in that analysis before that one that was terminated by opening the external contact).

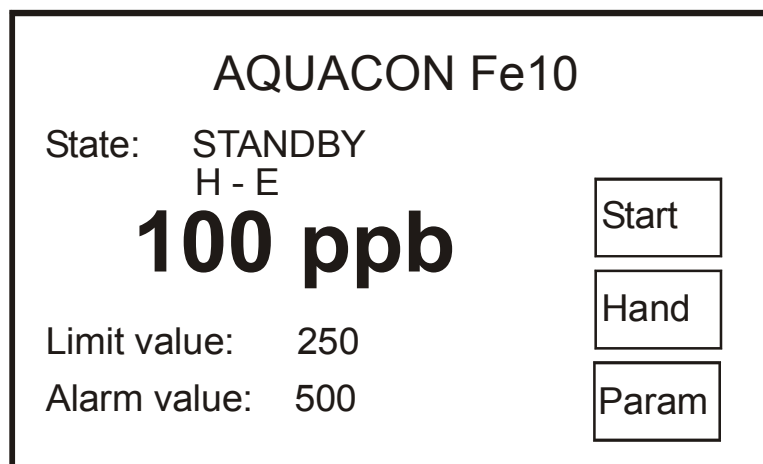

When an error message occurs this will be displayed additional to „H-E“.

### 4.3 Analysis state relay

The analysis state relay K 1 is activated during the time when the analyzer operates an analysis.

#### **4.4 Limit Value Relay**

The potential-free limit value K 2 relay is activated when the end-user defined limit is exceeded. During the automatic operation mode, “limit value” will be displayed when the measurement results are higher than the set limit value.

#### **4.5 Alarm Limit Relay**

The potential-free alarm relay is activated when an alarm is exceeded within the process photometer. The alarm is caused by an error in the optical system, when the measurement range is exceeded or when the reagent volume falls below than 50 ml. The appropriate alarm message will be displayed as “ERROR E-1, ERROR E-2, ERROR E-3” or “ERROR E-4” (see chapter 3.3).

#### **4.6 Current Output**

The process photometer AQUACON Fe10 delivers a current output, 0 or 4 to 20 mA, which is proportional to the measurement range selected by the end-user (see chapter 9.1). This current output may be used as input to remote recording devices, for data processing, controlling functions etc. The current output is independent of resistance load up to a value of 500 ohm. The start and end value of the current output signal can be set by the user within the measurement range.



**Don't connect any external voltage to the connections of the current output. Failure to observe this information could result in damage to the equipment.**

See above, " 3.6.3 Setting the Analog Output". To avoid resolution losses of the current output signal the user defined measuring range should be  $> 6\%$  of the total measurement range. The start value should be lower than the end value. Setting the start value higher than end value results in a constant output of 20 mA. Similarly, setting the end value lower than that of the start value results in a constant 0 or 4 mA output.



## 5 Start-up and Maintenance Instructions

### CAUTION:





As soon as the analyzer is connected to the main supply, automatic operation commences. This is required for automatic restart of the analyzer in the event of a power failure. At start-up, it is necessary to access the Manual Operating mode by touching the "Hand" button as soon as the analyzer is connected to main supply and is operational.

### 5.1 Connection of sample water

1. Connect inlet and outlet connectors (6/4; 8/6) max. length 5 m
2. Connect power supply to device  
**Caution:** see label on the housing for specified voltage
3. Select the sample inlet valve to „open“ (press button  on the touchscreen)
4. Carefully open the manually-operated valve beneath the solenoid operated valve to set the sample flow (20-30 l/h)

**Caution:** Maximum sample pressure 10 bar!

### 5.2 Connection of reagent, bleeding of pumps and tubes

1. Open the reagent vessel top. Ensure that the pump tube is installed and the pump head is screwed down.
2. Switch on the stirrer (button ) and the first pump (button ) in order to fill the suction-lances and pressure-tubes (Sign: the extinction in the display is rising).
3. After filling the tubes switch off the pump and stirrer.
4. If there is a second or third reagent available, repeat step 1-3 with this reagents.
5. Rinse the measuring chamber by activating the sample inlet valve (button ) and stirrer (button ) in order to wash out the reagent entered while filling the tubes
6. Select automatic operation (button ). The device now operates in automatic mode and start the measurement.

**Perform 2 to 3 analyses. Regard correct filling by observing the measurement outlet tube with the selected sample flow conditions. When satisfied that the system is performing correctly, the parameter settings may be carried out prior to automatic operation**

### 5.3 Replenishment of Reagent

The reagent bottle may be replaced, after setting the analyzer to manual mode. Now the volume of reagent must be entered in „Param“ mode step to 250 (if the volume of reagent 1 is 250 ml) or to 500 (if the volume of reagent 1 is 500 ml). See also chapter 3.6.7.

Important: The handling with chemical standards and reagents can be dangerous. Before the reagent bottles are connected or replaced, it is necessary to read their specific MSDS (material safety data sheets).

### 5.4 Changing of Tube box

Replacement of the complete tube-box by pressing the brackets at the sides, take off the old box and give up a new box.

#### **Important:**

**All tube boxes must be replaced after consumption of 5 bottles reagent or latest after 6 months.**

### **5.5 Recalibration of the Process analyzer**

Under normal conditions, a re-calibration of the process analyzer is not required since the reagent to sample ratio have been correctly determined at the time of manufacture. However should the need arise to verify the process analyzer, a standard solution may be introduced. In the unlikely event of a deviation from the introduced standard (incorrect reagent strength, pump tube aging, incorrect pump tube, contaminated measuring cell), a titer/calibration factor may be calculated as follows:

$$\text{titer/calibration factor} = \text{Standard solution value} : \text{Measured value}$$

Should the titer/calibration factor deviate by more than 20 % from 1, then a change of the tube box or a cleaning of the measurement chamber is maybe necessary.

### **5.6 Maintenance interval**

A maintenance of the analyzer should be made after 5 consumed reagent bottles or latest after 6 month. A maintenance should include at least an optical control of the analyser, a function control and a change of the tube boxes. If necessary, the maintenance should also include a cleaning of the measurement chamber and of the injectors for the tube connection at the measurement chamber.

### **5.7 Shut down procedure**

If the analyzer is shut down for an extended period of time, all reagents and samples should be removed out of tubings and the measurement chamber, and all tubings and the measurement chamber should be cleaned and flushed with deionized water.

## 6 Alarm Messages

Message in display	Description	ACTION
ERROR E -1	Error in the optical system; the analyzer operation is interrupted: - contaminated cuvette windows - defective light source - defective photodetector - no sample ( <b>NB Most likely cause of failure!</b> )	<b>Check sample inlet valve, clean the measuring chamber, call maintenance service.</b>
ERROR E -2	Measurement range exceeded	<b>Verify if iron concentration is too high. Check stirrer function.</b>
ERROR E -3	Reagent volume has dropped below the factory preset value of 50 ml. The operation of the analyzer remains unaffected until reagent is depleted.	<b>Replace reagent soon.</b>
ERROR E -4	Reagent depleted. The analyzer results are no longer valid.	<b>Replace reagent.</b>
H -E	Remote operation activated	

## 7 Technical Data

Current output	0/4 - 20 mA, max. load 500 ohm
Display	240 x 128 dots, Touchscreen
Relays	1 x Alarm, potential-free 230 V/50 Hz, 3A 1 x Limit, potential-free 230 V/50 Hz, 3A 1 x Analysis state, potential-free 230 V/50 Hz, 3A
External Switching	potential-free contact, 18 V DC, ca. 4 mA
Power Supply	110 - 230 V -- 50/ 60 Hz
Power Consumption	approx. 16 VA
Dimensions	640 x 315 x 190 mm (H x W x D)
Protection	IP 65 (transmitter housing)
Connections	Plugs with circular connection 1,5 mm <sup>2</sup>
Temperature	5° to 45°C, at consumption of reagents within 6 months

**Since it is company policy to continuously improve its product range, we reserve the right to make changes in the product design without notification to its users**

## 8 Specifications

Parameter	Iron (dissolved, sum Fe <sup>2+</sup> ,Fe <sup>3+</sup> )
<b>Description</b>	Automatic microprocessor controlled analyser for the photometric determination of total dissolved iron
	<b>AQUACON Fe-10</b>
<b>Typical Applications</b>	Control of industrial effluent of steel facilities; corrosion control in closed water cycles; analysis of drinking water
<b>Method of working</b>	Photometric measurement of total dissolved iron by the formation of a Pyridyl-triazin complex
<b>Measuring Range</b>	10 – 500 ppb Fe
<b>Resolution</b>	1 ppb
<b>Accuracy</b>	2 % of end value
<b>Reproducibility</b>	1 % of end value
<b>Zero-point Stability</b>	automatic readjustment
<b>Number of samples</b>	1
<b>Sample</b>	
Operating Pressure	0,1 - 10 bar
Temperature	5 - 30 °C
Sample Volume	25 ml per analysis (without rinsing volume)
Sample Condition	clear, filtrated
Chemical Demands	pH 6 – 8
Drain	without pressure
<b>Reagents</b>	
Number	3
Storage Temperature	0 – 30°C
Usage/analysis	appr. 0,8 ml /Reagents
Reagent volume	250/250/250 ml
Suitable for analysis	appr. 300
<b>Analysis</b>	
Cycle (approx.)	7 min (incl. rinsing time)
Sample interval	1 min-99 min

## 9 Connection Diagram

### 9.1 Set 0/4 - 20 mA-Output

The 0/4 – 20 mA output can be set by changing the appropriate parameters (see chapter 3.6.3).

## 9.2 Connections

In – and outputs are available at circular connectors at the top of the device.



**CAUTION: technical data !**

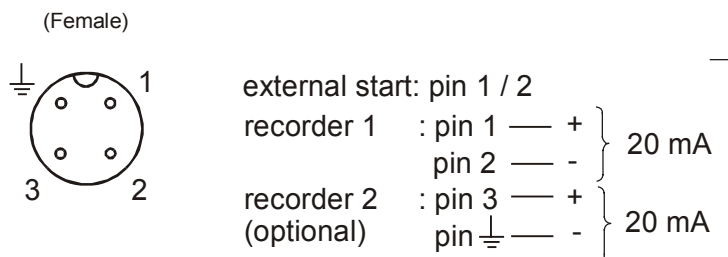
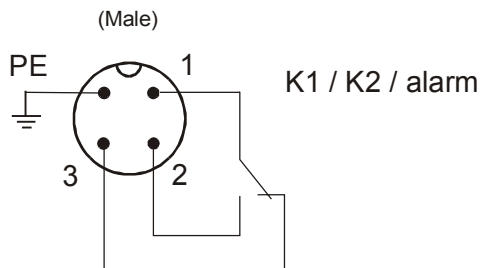
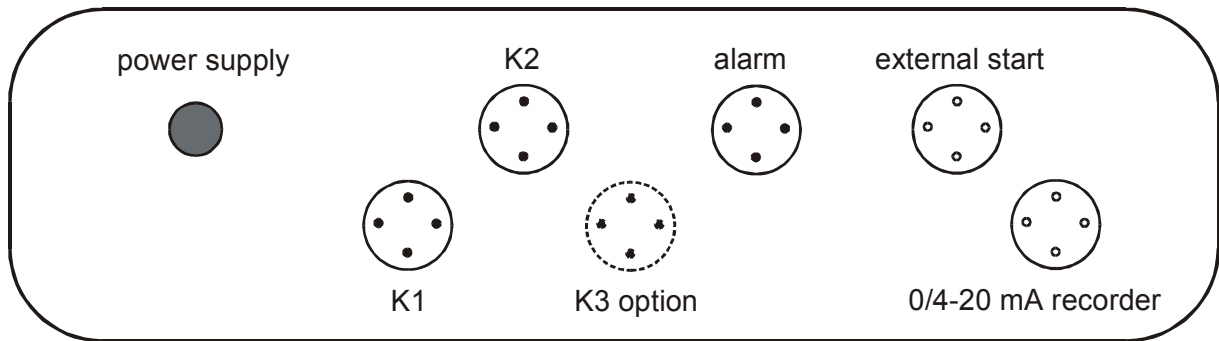

**caution !**

do not connect any voltage to these terminals

Power supply	Power supply (110 - 230 V, 50/60 Hz)	PE	protection earth
K1	Analysis status signal	K2	Limit value relay 1
external start	potential-free input contact	alarm	alarm limit relay
20 mA recorder 1	0/4 – 20 mA output (max. load 500 Ω)	K3	Limit value relay 2
20 mA recorder 2 (optional)	0/4 – 20 mA output (max. load 500 Ω)		(optional)

### 9.3 Installation



## WARNING

**Only Qualified Personnel !**

**Only Specified Power Supply !**

See required power supply as noted on instrument.

**Observe local regulations!**







Install a power supply that can be disconnected (plug, switch).

Take care for use of the protective covers for not used connectors.

Do not install measuring-or control cables in parallel or close distance in the same cable guide with power supply.

## 10 Appendix

### 10.1 Analysis cycle Fe10

Length	Operation					
				1	2	3
15 -99 s	Rinsing of the measurement chamber		X			
10 s	Sample degasification	X				
~ 40 s	Automatic zero adjustment					
3 s	Injection of the Reagent R1	X		X		
3 min	Mixing	X				
3 s	Injection of the Reagent R2	X			X	
3 s	Injection of the Reagent R3	X				X
3 min	Mixing	X				
11 s	Measurement					
20 s	Rinsing of the measurement chamber	X	X			
1 - 99 min.	Break time					

**10.2 Spare part and consumable item list**

Consumable item	Term	Quantity	Order No
Reagent 1 for AQUACON FE10	FE10 R1001	250 ml	101 2754 01
Reagent 2 for AQUACON FE10	FE10 R1002	250 ml	102 2754 01
Reagent 3 for AQUACON FE10	FE10 R1003	250 ml	103 2754 01
Tube - box	SK10	1 piece	121 0037 01
spare parts			Order No
Transmission pressure tubing	PT10	1 m	121 0014 01
Tube pump	SP10-2	1 piece	121 0008 02
Magnetic valve type 1 2/2 way (brass)	MV01-G	1 piece	121 0004 02
Magnetic stirring bar for measuring chamber			121 0044 01
Glass measuring cuvette			121 0045 01

Basic equipment of consumables are included in price



## 11 Troubleshooting Guide

Problem	Reason
On pressing the „automatic operation“ key switch, the analyzer does not enter automatic analysis cycle.	<ul style="list-style-type: none"> <li>• The contact bridge for external switch function (see 4.1) is not installed or has no contact switch. „H-E“ appears in the display. <b>Solution:</b> install bridge</li> <li>• The measurement chamber is empty (i.e. no sample) or the sample is strongly coloured or contaminated. „ERROR E-1“ appears in the display. The analyzer will automatically re-enter the measurement cycle following the sample interval and reset the alarm <b>Solution:</b> clean the measurement cuvette with 10% hydrochloric acid, check sample flow, check optical components (open measurement chamber and set analyzer to manual operation. The displayed absorption should increase when the optical path is restricted by an opaque object)</li> <li>• Reagent is depleted or incorrect reagent volume entered. „ERROR E-4“ appears in the display. <b>Solution:</b> Replace reagent if depleted and reset reagent volume to the correct volume via parameter input..</li> </ul>
The analyzer continuously displays setpoint overrange	<ul style="list-style-type: none"> <li>• The setpoint selected is below the measured value. „ERROR E-2“ appears in the display. <b>Solution:</b> Verify the measured value by alternative analysis Increase setpoint value</li> </ul>
The values displayed are erratic even though the actual measured variable is constant	<ul style="list-style-type: none"> <li>• Reagent container is not opened to atmosphere. Vacuum drawn on the reagent vessel. <b>Solution:</b> Open the reagent bottle cap to release vacuum. Do not retighten.</li> <li>• Magnetic stirrer immobilised <b>Solution:</b> Open the measurement cuvette. Stirrer is switched on by manual operation. Check that the magnetic follower is not jammed by loosening gently with a glass stirring rod. Increase the motor voltage by adjusting the appropriate potentiometer in the terminal box. If the problem is not rectified, call Service.</li> <li>• Reagent tubing is kinked or the feed tube in the reagent container is pushed against the bottom of the vessel. <b>Solution:</b> Straighten all tubes and tilt feed tube away from the bottom of the reagent container</li> <li>• Sample pressure is too low to effectively flush the measuring cuvette after analysis The cuvette does not overflow or overflows very slowly during flushing cycle. <b>Solution:</b> Increase the sample pressure to above 0.1 bar. Open sample inlet valve to allow 100 - 200 ml water flow per analysis cycle..</li> </ul>
A calibration factor differing widely from 1.00 must be used to achieve correct results	<ul style="list-style-type: none"> <li>• Reagent is contaminated, reagent has expired, pump tube has exceeded. <b>Solution:</b> replace reagent; replace pump tubing.</li> </ul>
Pumps or solenoid operated valves do not operate in manual mode	<ul style="list-style-type: none"> <li>• a limited number of electromechanical drives may be simultaneously selected to prevent electrical overload. <b>Solution:</b> Switch off other electromechanical drives and try again.</li> </ul>